

RFX8210
RFX8220
RFX8230



RFX



SOURCE UNITS
INSTALLATION & OPERATION

Dear Customer,

Congratulations on your purchase of the world's finest brand of car audio source units. At Rockford Fosgate we are committed to musical reproduction at its best, and we are pleased you chose our product. Through years of engineering expertise, hand craftsmanship and critical testing procedures, we have created a wide range of products that reproduce music with all the clarity and richness you deserve.

For maximum performance we recommend you have your new Rockford Fosgate product installed by an Authorized Rockford Fosgate Dealer, as we provide specialized training through Rockford Technical Training Institute (RTTI). Please read your warranty and retain your receipt and original carton for possible future use.

To add the finishing touch to your new Rockford Fosgate image order your Rockford accessories, which include everything from T-shirts and jackets to hats and sunglasses.

To get a free brochure on Rockford Fosgate products and Rockford accessories, in the U.S. call 480-967-3565 or FAX 480-967-8132. For all other countries, call +001-480-967-3565 or FAX +001-480-967-8132.

PRACTICE SAFE SOUND™

Continuous exposure to sound pressure levels over 100dB may cause permanent hearing loss. High powered autosound systems may produce sound pressure levels well over 130dB. Use common sense and practice safe sound.

If, after reading your manual, you still have questions regarding this product, we recommend that you see your Rockford Fosgate dealer. If you need further assistance, you can call us direct at 1-800-669-9899. Be sure to have your serial number, model number and date of purchase available when you call.

The serial number can be found on the outside of the box. Please record it in the space provided below as your permanent record. This will serve as verification of your factory warranty and may become useful in recovering your source unit if it is ever stolen.

Serial Number: _____

Model Number: _____

SPECIFICATIONS

General

Operating Voltage	+10.8V – +16.0V DC
Standby Current	5mA Max
Operating Temperature	-30°C to +70°C (Receiver) -10°C to +65°C (CD Player)
Dynamic Power Rating (IHF-202 Standard) per channel into a 4Ω load	40 watts x 4 (8210/8220/8230)
RMS continuous power per channel , all channels driven into a 4Ω load from 20-20,000Hz with less than 0.1% Total Harmonic Distortion (THD)	25 watts x 4 (8210/8220/8230)
Speaker Impedance	4Ω – 8Ω
Preamp Output Voltage	2.4VRMS @ 0.1% THD
Sum Preamp Output Voltage*	2.4VRMS @ 0.1% THD
Preamp Output Impedance	<100Ω
Equalization	Bass: ±10dB @ 60Hz Treble: ±8dB @ 15kHz
IR Receiver Eye Range	±45° off axis
Overall Dimensions (with trim-ring)	2-9/32"(H) x 7-13/32"(W) x 7-1/4"(D) (58mm x 188mm x 183.7mm)
Nosepiece Dimensions (without trim-ring)	1-27/32"(H) x 6-3/4"(W) x 13/16"(D) (46.5mm x 171.5mm x 20.2mm)
Weight	
8210	3.13lbs (1.42kg)
8220	3.18lbs (1.44kg)
8230	3.20lbs (1.45kg)

*Feature available on RFX8220 & RFX8230 only

TABLE OF CONTENTS

FM Tuner

Tuning Range	
Americas	87.5 ~ 107.9MHz (200kHz spacing)
Eur/Aus	87.5 ~ 108MHz (50kHz spacing)
Frequency Response	30Hz – 12kHz
Usable Sensitivity	10dB (S/N 30dB)
IF Rejection	90dB
Image Rejection	50dB
Signal-to-Noise Ratio	60dB
Distortion	< 0.5%
Channel Separation	≥ 25dB @ 1kHz
Suppression	35dB

AM Tuner

Tuning Range	
Americas	530 ~ 1710kHz (10kHz spacing)
Eur/Aus	522 ~ 1620kHz (9kHz spacing)
Sensitivity	20dBf max @ 10dB sensitivity
-6dB Bandwidth	5kHz min – 12kHz max

CD Player

Compatible Discs	5" or 3"
Frequency Response	20Hz – 20kHz (±3dB)
Signal-to-Noise Ratio	>90dB (preamp output w/ 22kHz LP filter)
Distortion	<0.5%
Channel Separation	86dB (preamp output w/ 22kHz LP filter)
Dynamic Range	100dB

IR Remote

(optional with RFX8210)

Operation Voltage	+3V DC
Transmitting Range	20 ft (variable in sunlight)
Battery Replacement	(1) CR2025 +3V Lithium
Dimensions	3-3/8"(H) x 2-1/8"(W) x 9/32"(D) (85.6mm x 54mm x 7mm)

Specifications	1
Introduction	4
Accessory Pack	4
Precautions	5
“Quick Look” Features Matrix	7
Source Unit Design Features	9
IR Remote Design Features	12
Installation Considerations	14
Source Unit Mounting Locations	15
Wiring the System	16
Installation	18
Basic Operation	21
Tuner Operation	29
CD Player / CD Changer Operation	33
CD Changer Operation	41
Auxilliary Audio Operation	45
IR Remote Operation	46
Troubleshooting	61
Warranty Information	68

GETTING STARTED

Welcome to Rockford Fosgate! This manual is designed to provide information for the owner, salesperson and installer. For those of you who want quick information on how to install this product, please turn to the **Installation Section** of this manual. Other information can be located by using the Table of Contents. We, at Rockford Fosgate, have worked very hard to make sure all the information in this manual is current. But, as we are constantly finding new ways to improve our product, this information is subject to change without notice.

NOTE: This manual uses abbreviations for the following terms:

TUNER = AM/FM Radio Tuner
CDP = In-Dash CD Player
CDX = CD Changer *(optional)*
AUX = External Auxiliary Input *(RFX8230 only)*

INTRODUCTION

Rockford Fosgate optimizes various features in the RFX source units for use in high performance car audio systems. A great tuner, a high performance CD player, and controls pioneered by Rockford Fosgate give you total control of your audio system!

The following sections contain information on the features, installation, and operation for the 8210, 8220, & 8230 source units. For comparisons within the RFX line, refer to the "Quick Look" feature chart in this manual. For long term reliability of your new Rockford Fosgate source unit, please read the Precautions section on the next page.

ACCESSORY PACK

RFX8210

Installation & Operation Manual

- (1) Mounting Sleeve
- (1) Backstrap
- (2) Chassis Release Keys
- (1) Hardware Package
- (1) 8210/8220 16-pin Power Harness
- (1) Faceplate Case

RFX8220

Installation & Operation Manual

- (1) Mounting Sleeve
- (1) Backstrap
- (2) Chassis Release Keys
- (1) Hardware Package
- (1) 8810/8220 16-pin Power Harness
- (1) Faceplate Case
- (1) IR Remote Control

RFX8230

Installation & Operation Manual

- (1) Mounting Sleeve
- (1) Backstrap
- (2) Chassis Release Keys
- (1) Hardware Package
- (1) RFX8230 16-pin Power/Aux-In Harness
- (1) Faceplate Case
- (1) IR Remote Control

PRECAUTIONS

Source Unit & Optional CD Changer

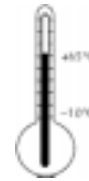

Operating Temperature

Be sure the temperature inside the vehicle is between -10°C and $+65^{\circ}\text{C}$ ($+14^{\circ}\text{F}$ and $+149^{\circ}\text{F}$). **DO NOT** play a disc if the temperature is higher or lower than the operating range.



Moisture Condensation

The CD playback may waver due to condensation. If this occurs, remove the disc from the source unit and wait approximately an hour for the moisture to evaporate.



Environment Exposure

DO NOT expose the Source Unit or optional CD Changer to any of the following: direct sun and heat, high humidity, excessive dust, excessive vibration and rain or water.



Handling the Detachable Faceplate

DO NOT drop or cause shock to the faceplate as serious damage may occur. Protect the faceplate by storing it in the supplied carrying case.



Avoid Mechanical Malfunction

DO NOT grab a disc while it is being automatically loaded into the source unit. Doing this may cause serious damage to the playback mechanism.

Compact Discs

Disc Handling and Care



DO NOT touch the playing side (opposite of label side) of the disc. When handling the disc, only the outer edges or center hole of the disc should be touched. **DO NOT** affix any sticker or label to the disc. **DO NOT** apply vinyl record spray, anti-static agent, acetone, or any other volatile chemicals to the disc.

Damaged Disc



DO NOT play a cracked, warped or damaged disc. Doing this may cause serious damage to the playback mechanism.

New Discs



The CD player will eject discs that have either been inserted incorrectly or have irregular surfaces. If a new disc is ejected after loading, feel around the outer edge of the CD and its center hole. Any small burrs or irregularities could inhibit proper loading of the disc. To remove the burrs, rub the inside edge of the hole and outside edge of the disc with an object such as a ball point pen.

IR Remote (RFX8220/RFX8230)



Environment Exposure

DO NOT expose the IR Remote to any of the following: direct sun and heat, high humidity and rain or water.



Handling the IR Remote

DO NOT drop or cause shock to the IR Remote as serious damage may occur.

QUICK LOOK FEATURES	RFX8210	RFX8220	RFX8230	RFX8810
Control/Lighting/Appearance				
Detachable Faceplate	X	X	X	-
ISO Din Mounting w/ Removable Trim Panel	X	X	X	-
Multi Function Volume Knob	X	X	X	-
Any Button Wake-Up	X	X	X	-
Time of Day Clock	X	X	X	-
Programmable Default Display	X	X	X	-
Negative Image LCD Display	X	X	X	-
IR Remote Compatible	X	X	X	-
Illumination "ON" w/ Ignition	X	X	X	-
Display Back Lighting	Green	Green/Amber	Green/Amber	-
IR Remote Included	-	X	X	-
Tuner				
World Wide Tuning	X	X	X	-
AM mono/FM stereo	X	X	X	-
FM Noise Blanker	X	X	X	-
Auto Blend / Roll Off	X	X	X	-
Multi-Path Interference Rejection	X	X	X	-
12 AM / 18 FM Presets	X	X	X	-
AM1/AM2/FM1/FM2/FM3	X	X	X	-
Preset Scan	X	X	X	-
Auto Store Non-Volatile Presets	X	X	X	-
AM/FM Seek	X	X	X	-
AM/FM Manual Tuning	X	X	X	-
AM/FM Scan	X	X	X	-
Pause (MUTE)	X	X	X	-
Programmable Station Titles	-	X	X	-
CD Player				
Dual 1-bit D/A Converters w/ 8 x oversampling	X	X	X	-
Ignition Off Disc Load/Eject	X	X	X	-
Repeat Mode	X	X	X	-
Random Play (CD)	X	X	X	-
Track Scan	X	X	X	-
Fast Forward/Reverse	X	X	X	-

QUICK LOOK FEATURES	RFX8210	RFX8220	RFX8230	RFX8810
Next/Previous Track	X	X	X	-
Programmable Eject Mute Off	X	X	X	-
Insert Disc Power Up/Play	X	X	X	-
Pause/Resume Play	X	X	X	-
Programmable Disc Titles	-	-	X	-
Pre Amp/Power				
Source Tone Memory	X	X	X	-
Switchable Loudness	X	X	X	-
Electronic Volume, Tone, Balance	X	X	X	-
Internal Audio Amplifier	25 watts RMS (40 max) x 4	25 watts RMS (40 max) x 4	25 watts RMS (40 max) x 4	-
Number of Preouts	4 RCA	6 RCA	6 RCA	-
Front/Rear Sum Preout (#5 & #6)	-	X	X	-
Preout Voltage	2.4 volts RMS	2.4 volts RMS	2.4 volts RMS	-
Low Source Impedance	< 100Ω	< 100Ω	< 100Ω	-
External Audio Inputs (AUX-IN)	-	-	X	-
Remote Functions				
	IR optional	IR included	IR included	-
Tuner, CD and Changer Mode	X	X	X	X
Volume Up/Down	X	X	X	X
Seek (Track) Up/Down	X	X	X	X
Fast Forward/Reverse	X	X	X	X
Tune (Disc) Up/Down	X	X	X	X
Pause/Resume Play	X	X	X	X
Direct Preset Access	X	X	X	-
Direct Track Access	X	X	X	X
Direct Disc Access	-	-	-	X
CD Changer Control				
Dual 1-bit D/A Converters w/ 8 x oversampling	X	X	X	X
CD Changer Controller	X	X	X	-
Changer Repeat Mode	X	X	X	X
Changer Random Play	X	X	X	X
Pause/Resume Play	X	X	X	X
Changer Track Scan	X	X	X	X
Changer Disc Scan	X	X	X	X

Source Unit Design



- BAND** – Selects which bank of tuner presets (FM1/FM2/ FM3/AM1/AM2) should be active.
- POWER** – Turns the source unit on and off.
- EJECT** – Ejects the CD from the in-dash CD player.
- DISP** – Switches the source unit between the clock and the currently selected mode (TUNER/CDP/CDX/AUX*).
- MODE** – Selects between TUNER/CDP/CDX/AUX* modes.
- MENU** – Selects between Volume/Bass/Treble/Balance/ Fader/Sum** modes.
- SEEK/TRACK** – Selects the previous/next radio station in TUNER mode and selects the previous/next track in CDP/CDX mode.
- PRESET 1/SCAN** – Selects radio preset #1 in TUNER mode and scans each track on the disc in CDP/CDX mode.
- PRESET 2/RPT** – Selects radio preset #2 in TUNER mode and repeats the current track in CDP/CDX mode.

*Features available on RFX8230 only

**Features available on RFX8220 & RFX8230 only

10. **PRESET 3/RDM** – Selects radio preset #3 in TUNER mode and selects tracks at random in CDP/CDX mode.
11. **PRESET 4** – Selects radio preset #4 in TUNER mode.
12. **PRESET 5** – Selects radio preset #5 in TUNER mode.
13. **PRESET 6** – Selects radio preset #6 in TUNER mode.
14. **TUNE/DISC** – Manually tunes the radio station in TUNER mode and selects previous/next disc in CDX mode.
15. **RELEASE** – Detaches the faceplate from the source unit.
16. **LOUD** – Enables bass response to be boosted at low and high levels
17. **AS/PS** – Press and hold to store the strongest radio stations in each tuner bank in AUTO STORE mode. Momentarily press to scan each radio preset in PRESET SCAN mode.
18. **MUTE** – Mutes the audio in TUNER/AUX* modes and pauses the disc in CDP/CDX mode.

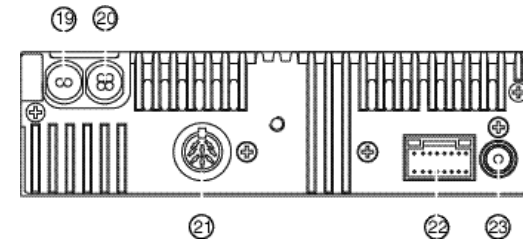

19. **Sum Preamp Output**** – These RCA jacks provide a low-level SUMMED MONO (L+R) output used to connect amplifier(s) driving subwoofers.
20. **Front/Rear Preamp Output** – These RCA jacks provide a low-level STEREO output used connect amplifier(s) driving front & rear speakers.
21. **CD Changer Input** – This 8-pin DIN is used to connect an optional RFX CD Changer to the source unit.
22. **Power Connector** – The 16-pin molex is used for power, speaker, and AUX* connections.
23. **Antenna Input** – Connects a standard male Motorola coaxial radio antenna to the source unit.

IMPORTANT: The communication BUS used in Rockford Fosgate models RFX8210/8220/8230 is used only for CD changer model RFX8810 and is not backward compatible with older RFX models. Rockford Fosgate recommends connecting only the appropriate RFX models together. Rockford Fosgate does not assume responsibility when using other manufacturers' source units with Rockford Fosgate CD changers (or vice versa).

*Feature available on RFX8230 only

*Feature available on RFX8230 only

**Feature available on RFX8220 & RFX8230 only

IR REMOTE DESIGN FEATURES

(RFX8210 optional accessory)

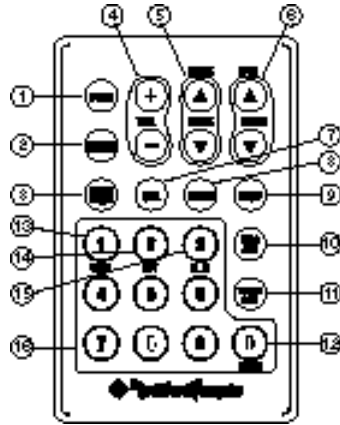

1. **POWER** – Turns the source unit on and off.
2. **MODE** – Selects between TUNER/CDP/CDX/AUX* modes.
3. **MUTE** – Mutes the audio in TUNER/AUX* modes and pauses the disc in CDP/CDX mode.
4. **VOL** – Controls Volume/Bass/Treble/Balance/Fader/Sum**
5. **SEEK/TRACK** – Selects the previous/next radio station in TUNER mode and selects the previous/next track in CDP/CDX mode.
6. **TUNE/DISC** – Manually tunes the radio station in TUNER mode and the previous/next disc in CD mode.
7. **SEL** – Selects between Volume/Bass/Treble/Balance/Fader/Sum** modes.
8. **BAND** – Selects which bank of tuner presets (FM1/FM2/FM3/AM1/AM2) should be active.

9. **DISP** – Switches the source unit between the clock and the currently selected mode (TUNER/CDP/CDX/AUX*).
10. **DISC ACC** – Directly accesses the desired CD in the optional CD changer.
11. **TRACK ACC** – Directly accesses the desired track in the in-dash CD player
12. **AS/PS** – Press and hold to store the strongest radio stations in each tuner bank in AUTO STORE mode. Momentarily press to scan each radio preset in PRESET SCAN mode.
13. **SCAN** – Scans each track on the disc in CDP/CDX mode.
14. **RPT** – Repeats the track in CD/CDX mode.
15. **RDM** – Selects tracks at random in CDP/CDX mode.
16. **0-9 BUTTONS** – Selects presets 1-6 in TUNER mode, selects tracks in CDP & CDX mode, and selects discs in CDX mode.

*Features available on RFX8230 only

**Features available on RFX8220 & RFX8230 only

INSTALLATION CONSIDERATIONS

The following is a list of tools needed for installing the Source Unit:

Volt/Ohm Meter	#2 Phillips screwdriver
Wire strippers	Battery post wrench
Wire crimpers	Soldering iron
Wire cutters	Solder
1/8" diameter heatshrink tubing	Heat gun

This section focuses on some of the vehicle considerations for installing your new Source Unit. Pre-planning your system layout and best wiring routes will save installation time. When deciding on the layout of your new system, be sure that each component will be easily accessible for making adjustments.

Before beginning any installation, be sure to follow these simple rules:

1. Be sure to carefully read and understand the instructions before attempting to install the Source Unit.
2. **For safety**, disconnect the negative lead from the battery prior to beginning the installation.
3. For easier assembly, we suggest you run all wires prior to mounting your Source Unit in place.
4. Route all of the RCA cables close together and away from any high current wires.
5. Use high quality connectors for a reliable installation and to minimize signal or power loss.
6. **Think before you drill!** Be careful not to cut or drill into gas tanks, fuel lines, brake or hydraulic lines, vacuum lines or electrical wiring when working on any vehicle.
7. Never run wires underneath the vehicle. Running the wires inside the vehicle provides the best protection.
8. Avoid running wires over or through sharp edges. Use rubber or plastic grommets to protect any wires routed through metal, especially the firewall.
9. **ALWAYS** protect the battery and electrical system from damage with proper fusing. Install the appropriate fuseholder and fuse on the +12V power wire within 18" (45.7 cm) of the battery terminal.
10. When grounding to the chassis of the vehicle, scrape all paint from the metal to ensure a good, clean ground connection. Grounding connections should be as short as possible and always be connected to metal that is welded to the main body, or chassis, of the vehicle.

SOURCE UNIT MOUNTING LOCATIONS

The mounting position of your source unit will have a great effect on the performance of your in-dash CD Player. The source unit can be installed in a wide range of operating locations. However, care should be taken to ensure optimum performance.

Engine Compartment

Mounting the source unit in the engine compartment will **void your warranty**. Doing so will not only cause severe damage to your new source unit...but will immediately promote you to "customer of the month" in our technical support department.

Instrument Panel

Mounting the source unit in the **instrument panel provides optimum access**. The source unit should be securely mounted using the "Standard Mount" or "ISO Mount" method to ensure optimum CD Player performance.

Center Console

Mounting the source unit in the **center console provides optimum access**. Be sure the installation does not interfere with the operation of the gear shift or parking brake. **The source unit should have a mounting angle within $\pm 20^\circ$ from horizontal.**

Glove Box

Mounting the source unit in the **glove box is adequate**, but does not provide easy access. Glove box mounting should only be done if "Instrument Panel" or "Center Console," mounting is not acceptable (i.e., maintaining integrity of older vehicles with metal dashboards.) **The source unit should be mounted within $\pm 20^\circ$ from horizontal.**

Under Dash

Mounting the source unit **under the dash is adequate**, but does not provide easy access. Under dash mounting should only be done if "Instrument Panel," "Center Console" or "Glove Box" mounting is not acceptable. Mount the source unit off to the side of the driver's area to reduce interference with the parking brake, gear shift, or operating pedals. **The source unit should be mounted within $\pm 20^\circ$ from horizontal.**

WIRING THE SYSTEM

NOTICE: If you do not feel comfortable with wiring your new source unit, please see your local Authorized Rockford Fosgate Dealer for installation.

- **For safety**, disconnect the negative lead from the battery prior to beginning the installation.
1. **Install the 16-Pin Power Harness** by connecting the corresponding wires to the electrical and audio system. Solder and heat shrink all connections for a reliable installation. For each connection, cut a 1" piece of heat shrink tubing and slide over one of the wires. Strip each wire 3/8" then twist together and solder. Slide the tubing over the connection and shrink the tubing with a hot air gun until no bare wire is exposed.
 2. **Connect the BLACK wire to chassis ground.** Prepare the chassis ground by scraping any paint from the metal surface and thoroughly clean the area of all dirt and grease. Strip the end of the wire and attach a ring connector. Fasten the wire to the chassis using a non-anodized screw and star washer.
 3. **Connect the YELLOW wire to a source of constant +12V (for retaining memory on user-programmed functions).** Connect the Yellow wire to a constant +12 volt positive source. The source should always have +12V, even when the ignition is off and the car is not running.
 4. **Connect the RED wire (Ignition) to a source of switched +12V (is on only when ignition key is in "accessory" or "run").** Connect the RED wire to a switched +12 volt positive source. The switched signal is usually taken from the ACC (accessory) position of the ignition. If the vehicle does not have an ACC position, connect the wire to the switched ON position of the ignition. The current consumption through this wire is negligible.
 5. **Connect the LT. BLUE wire to the "Remote Turn-On" leads of the amplifier(s).** This will turn-on the external amplifiers when the source unit is powered on.
 6. **Connect the BLUE/RED wire to the "Power Antenna" lead.** This will raise a fully automatic antenna when the source unit is powered on.

7. **Connect the B+, GND and Remote Turn on Wires on the 16 pin harness according to the Installation Reference Sheet.**
8. **Connect the AUX* to the external audio source (this inserts the audio before the volume control on the source unit).** The maximum un-clipped input voltage this circuit can accept is 2.4V RMS.

Connect the Speaker Wires (if external amplifiers are not used) to the corresponding speaker leads by soldering and heat shrinking all connections for a reliable installation. If only one pair of speakers is utilized in the system, use only the FRONT speaker leads and heat shrink the unused REAR leads to prevent from shorting out. Be sure to maintain speaker polarity. **DO NOT chassis ground any speaker leads as unstable operation may result.**

9. **Install the Preamp Output Harness** (if external amplifiers will be used) by plugging the RCA cables into the corresponding extension RCAs that feed the input of the amplifiers. Be sure to route the signal cables away from any high current wires to prevent coupling noise from radiated electrical fields into the audio signal.
The FRONT RCAs connect to the Front speaker's amplifier.
The REAR RCAs connect to the Rear speaker's amplifier.
The SUM RCAs connect to the Subwoofer amplifier.**
10. **Connect the CD Changer (optional)** by plugging the 8-pin DIN cable into the connector located at the rear of the source unit.
11. **Connect the Antenna** by plugging the antenna cable into the connector located at the rear of the source unit. Be sure the antenna is securely grounded to the vehicle for proper radio reception.

*Feature available on RFX8230 only

**Feature available on RFX8220 & RFX8230 only

SOURCE UNIT INSTALLATION

Source Unit Mounting Angle

- Mount the Source Unit as close to horizontal as possible for optimum CD Player performance
- Mounting Angles up to $\pm 20^\circ$ from horizontal can be accommodated

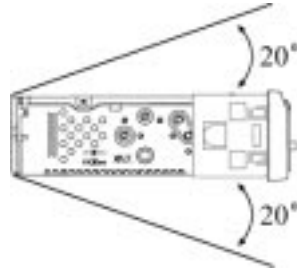

Using the Installation Sleeve - Standard Mount

Thickness	All Tabs Labelled Top, Bottom, and Sides							
	A	B	C	D	E	F	G	H
1.2mm to 1.5mm					*	*		
1.2mm to 11.3mm						*		
2.0mm to 7.0mm	*					*		
2.9mm to 10.4mm		*				*		
5.2mm to 10.4mm			*			*		
6.3mm to 8.8mm				*		*		
14.0mm to 19.8mm							*	
18.3mm to 20.8mm								*

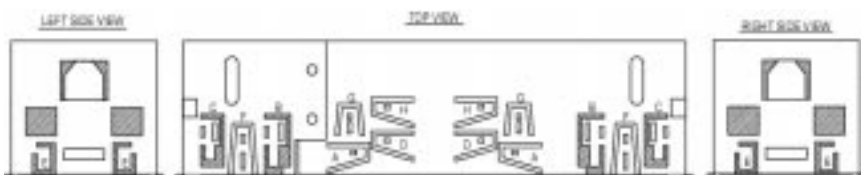

- Mount the Installation Sleeve into a secure instrument panel
- Bend Tabs on the installation sleeve which correspond to the chart above
- Bend Appropriate Tabs on all sides of the mounting sleeve (Top, Bottom, Left & Right)

Installing the Source Unit – Standard Mount

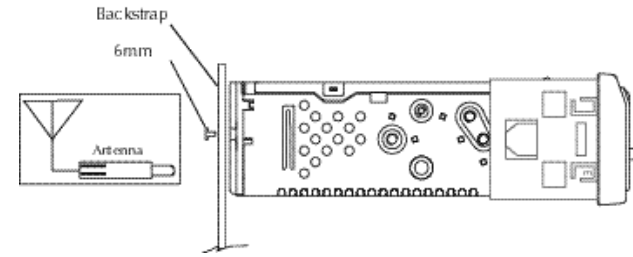

CAUTION: Installation sleeve should be installed using the appropriate tabs (refer to previous page)

- Install Source Unit by sliding unit into installation sleeve until it clicks into place
- Mount Backstrap securely behind the instrument panel to prevent source unit vibration
- Backstrap Screw should be 6mm max (use supplied screw)
- Connect Antenna to antenna jack on rear of source unit
- Antenna Ground should read less than 0.05Ω between antenna and chassis ground

Installing the Source Unit – ISO-DIN Mount

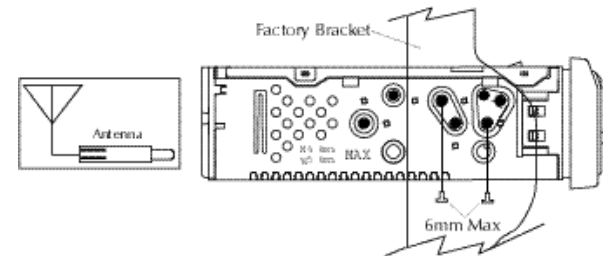

- Remove Trim Piece and Installation Sleeve from source unit
- Factory Bracket should align with two mounting holes on each side of source unit
- ISO Screws should be 6mm max (use supplied screws)
- Connect Antenna to antenna jack on rear of source unit
- Antenna Ground should read less than 0.05Ω between antenna and chassis ground
- Install Source Unit into instrument panel

Un-Installing the Source Unit – Standard Mount

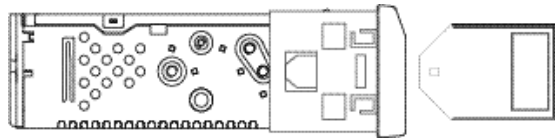

- **Disconnect Backstrap** from rear of radio (if used)
- **Insert Release Keys** into left and right sides of source unit to disengage locks
- **Remove Source Unit** from installation sleeve with release keys

Reset Button



- **Remove Faceplate** from source unit
- **Press Reset Button** if source unit gets jammed during operation

BASIC OPERATION



DETACHABLE FACEPLATE



The faceplate is detachable as an anti-theft deterrent system.

Attach the Faceplate

1. Insert left side of faceplate into the housing.
2. Press faceplate into housing until it clicks.

Remove the Faceplate

1. Press the “^” button
2. Grasp the right side of the faceplate and remove it from the housing

CAUTION: Store the faceplate in its carrying case to prevent damage



POWER ON/OFF



Operation

1. Press the power button to turn on the radio
2. Press the power button to turn off the radio

Any Button Wake-Up

Press any button on the faceplate (except EJECT, DISP) to "wake-up" the radio from sleep mode

LCD Display

When the radio is off (in sleep mode) the clock will be displayed

Power-up Defaults

Mode	Default
AS/PS	Off
Preset memory	Original memory band
Scan	Off
Repeat	Off
Random	Off
Loudness	On
Illumination color	Green
Default Display	Clock
CDP Loading	STBY
CDX Loading	Disc Start
Volume Level	12
Sum	50
Bass/Treble	0
Balance/Fader	0
Local/DX	DX
Station + Disc Titling	Clear Memory



TONE CONTROLS

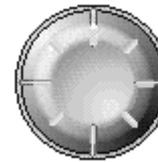

BAS ▲
 TRE ▲
 BAL ▲
 FAD ▲
 SUM** ▲
 VOL ▲

Operation

1. Press the MENU knob to cycle through BASS>TREBLE>BALANCE>FADER >SUM**>VOLUME
2. Turn the MENU knob clockwise to increase the selected function
3. Turn the MENU knob counter-clockwise to decrease the selected function

Function	Display	Range	Default
Volume	VOL	0 to 50	12
Bass	BAS	-8 to +8	0
Treble	TRE	-8 to +8	0
Balance	BAL	L15 to R15	0
Fader	FAD	R15 to F15	0
Sum Out	SUM**	0 to 50	50

Source Tone Memory

Individual Bass & Treble settings are memorized for TUNER / CD PLAYER / CD CHANGER / AUX*

NOTE: If no adjustment is made after 5 seconds, the MENU knob will revert to VOLUME mode.

*Features available on RFX8230 only

**Features available on RFX8220 & RFX8230 only



CLOCK OPERATION

(press & hold)



(press again)



Setting the Clock Hours

1. Press and hold the DISP button for 1 second until the hour digits flash
2. Press the SEEK UP/DN button to set the hour (be sure to select proper AM/PM setting)

Setting the Clock Minutes

1. Press and the DISP button a second time until the minute digits flash
2. Press the SEEK UP/DN button to set the minutes

Considerations

1. The clock will be displayed when the radio power button is turned off
2. Pressing the DISP button will display the clock for 5 seconds when an alternative default display is selected (see DEFAULT/RECALL DISPLAY in this section for more information on programming the default display).



DEFAULT/RECALL DISPLAY



AM 12:00
F1 101.5
KZON

AM 12:00
04 01:27
JANET J

AM 12:00
AUX

Display Recall temporarily displays the clock, radio station, station title**, CD track/time or disc title* or aux on the LCD for 5 seconds.

Display Recall (TUNER)

1. While in TUNER mode, press the DISP button to cycle through CLOCK>RADIO STATION>STATION TITLE**
2. After 5 seconds the LCD will revert to its default

Display Recall (CDP/CDX)

1. While in CDP/CDX mode, press the DISP button to cycle through CLOCK>TRACK/TIME>DISC TITLE*
2. After 5 seconds the LCD will revert to its default

Display Recall (AUX)

1. While in AUX mode, press the DISP button to switch between CLOCK>AUX*
2. After 5 seconds the LCD will revert to its default

Programming the Default Display

1. While in TUNER/CDP/CDX/AUX* mode, press and hold the DISP button until display flashes (clock set mode)
2. Press the MODE button to cycle through the available default displays
3. Release the MODE button for 1 second to lock-in the selected display
4. Default displays can be programmed independently for TUNER/CDP/CDX/AUX* modes

*Features available on RFX8230 only

**Features available on RFX8220 & RFX8230 only



LOUDNESS CONTROL

The Loudness control enables the bass response of the audio output to be boosted for low listening levels

Operation

1. Press the LOUD button to enable the Loudness feature.
2. Press the LOUD button a second time to disable the Loudness feature

Display

The LCD will display "LOUD" when the Loudness feature is enabled

Considerations

On initial power-up, the Loudness feature will default on



ON 
OFF 

ILLUMINATION COLOR*

Operation

1. Press and hold the LOUD button for 1 second to change the illumination from Green to Amber
2. Press and hold the LOUD button again to revert to the previous color

Considerations

On initial power-up, the illumination color will be Green

(press & hold)



ON 
OFF 

*Feature available on RFX8220 & RFX8230 only



STATION/DISC TITLE MEMORY

The name of the radio station or CD can be stored in memory using up to 8 characters as a title. A maximum of 58 titles can be stored into memory.

(press & hold)



Station/Disc Title Memory

1. Press and hold the BAND button for 1 second
2. Turn the MENU knob to select the proper character
3. Press the DISP button to change the character type to one of the following:
 Type #1: ABCDEFGHIJKLMNOPQRSTUVWXYZ
 Type #2: abcdefghijklmnopqrstuvwxyz
 Type #3: 0123456789
 Type #4: (\ \ . + ? ! * ")
4. Press the MENU knob to select the next space
5. Press and hold the MENU knob for 1 second to store the title into memory

(turn to select characters)



(press & hold)



Station/Disc Title Erasing

1. Press and hold the MUTE button for 1 second
2. Turn the MENU knob to select the title for erasing
3. Press and hold the MENU knob for 1 second to erase the title

TUNER OPERATION



TUNER MODE

(press & hold)



Operation

1. Press the MODE button to select TUNER MODE
2. Press the BAND button to select the appropriate tuner bank: FM1>FM2>FM3>AM1>AM2
3. Press one of the tuner presets (1-2-3-4-5-6) to recall the radio station stored in memory

Storing a Preset into Memory

1. Press the BAND button and select the tuner bank where the preset will be saved
2. Press the SEEK or TUNE button to select the desired radio station
3. Press and hold the desired PRESET BUTTON (1-2-3-4-5-6) for 1 second to store the radio station in memory

FM1 101.5



Seek

1. Press the SEEK UP button to automatically jump the tuner to the next strongest radio station
2. Press the SEEK DN button to automatically jump the tuner to the last strongest radio station



Tune

1. Press the TUNE UP button to manually tune the radio station up the band
2. Press the TUNE DN button to manually tune the radio station down the band



NOTE: Press and hold the TUNE UP/DN button for 1 second to speed up the manual tune mode.



AUTO STORE / PRESET SCAN

(press & hold)



FM1
FM2
FM3
AM1
AM2

Auto Store

1. Press and hold the AS/PS button for 1 second to automatically select the strongest radio stations and store them in the tuner banks
2. Auto Store will store radio stations independently in the selected tuner bank (FM1/FM2/FM3/ AM1/AM2)

Preset Scan

1. Press the AS/PS button to cycle through each radio station stored in memory. Each preset radio station will play for 5 seconds before moving to the next preset
2. Press the AS/PS button again to stop Preset Scan on the currently playing radio station



TUNER OPTIONS



Operation

1. Press and hold the MENU knob for 1 second to enter TUNER OPTIONS mode
2. Continue to press the MENU knob to cycle through TUNER OPTIONS #1>#2>#3
3. Press the SEEK button to select MODE 1 or MODE 2

Tuner Option	Mode	Function
#1	P.PLAY	Reverts the unit back to tuner mode when ejecting a CD
	EJ MUTE	Mutes the audio when ejecting a CD
#2	LOCAL	Adjusts the sensitivity for city conditions where there are several strong radio stations
	DX	Adjusts the sensitivity of the tuner for rural conditions where there are weak radio stations
#3	AMERICAS	Adjusts the tuner's frequency band for American country codes
	EUR/AUST	Adjusts the tuner's frequency band for European/Australian country codes

Country	Bandwidth	Frequency Spacing
Americas	AM = 530 - 1710kHz FM = 87.5 - 107.9MHz	10kHz 200kHz
Eur/Aus	AM = 522 - 1620kHz FM = 87.5 - 108.0MHz	9kHz 50kHz

CD Player Operation



TUNER MUTE



↓
MUTE

Operation

1. Press the MUTE button to reduce the volume to minimum
2. Press the MUTE button a second time to revert the audio to the previous level

LCD Display

The LCD will display MUTE until the function is canceled

CD PLAYER MODE



CDP Play

CD Player Mode

1. Press the MODE button until CDP PLAY is displayed
2. The CD player will immediately begin playing the disc

LCD Display

1. The track # & elapsed time will be displayed for 5 seconds
2. After 5 seconds the LCD will revert to the default display

NOTE: If no disc is loaded into the CD player NO CD will be displayed and the source unit will revert back to TUNER mode.

Insert CD and Play

1. Insert a disc to cancel the current mode
2. The disc will begin playing track #1 on the disc

Wake-Up Feature (when powered-off)

1. Insert a disc to power-on the source unit
2. The disc will begin playing track #1 on the disc



CDP/CDX TRACK SELECTION*



04 02:17

Track Selection

1. Press the SEEK UP button to select the next track on the disc
2. Press the SEEK DN button to select the previous track on the disc

LCD Display

1. The track # and elapsed time will be displayed for 5 seconds
2. After 5 seconds the LCD will revert to the default display

Considerations

CDP MODE: When the last track # is played on the disc, the player will start over and begin playing track #1 again.

CDX MODE: When the last track # on the current disc is reached, the next disc will load in the CD changer and begin playing track #1

**NOTE: This function works identically in both CD Player and CD Changer modes.*



CDP/CDX TRACK FORWARD/REVERSE*

(press & hold)



04 02:17

Fast Forward/Reverse

1. Press and hold the SEEK UP button to fast forward the track
2. Press and hold the SEEK DN button to fast rewind the track

LCD Display

The LCD will display the accelerated elapsed time for as long as the SEEK UP/DN button is depressed

**NOTE: This function works identically in both CD Player and CD Changer modes.*



CDP/CDX TRACK SCAN*

Track Scan plays the intro to each track for 10 seconds before moving to the next track on the currently playing disc

SCAN



04 00:10
 ↓
 05 00:10
 ↓
 06 00:10

Track Scan

1. Press the SCAN (Preset #1) button to begin track scan mode
2. Track scan will continue to scan until the mode is cancelled

Track Scan Cancel

1. Press the SCAN (Preset #1) button a second time to cancel track scan mode

LCD Display

1. The LCD will display SCAN until the function is cancelled
2. The LCD will display the track # and elapsed time for 5 seconds each time a new track begins its intro scan
3. After 5 seconds the LCD will revert to the default display

**NOTE: This function works identically in both CD Player and CD Changer modes.*



CDP/CDX TRACK REPEAT*

Track repeat plays the currently playing track over again

RPT



04 04:59
 ↓
 04 00:01

Track Repeat

1. Press the RPT (Preset #2) button to begin track repeat mode
2. Track repeat will continue to repeat the current track until the mode is cancelled

Track Repeat Cancel

1. Press the RPT (Preset #2) button a second time to cancel track repeat mode

LCD Display

1. The LCD will display RPT until the function is cancelled

**NOTE: This function works identically in both CD Player and CD Changer modes.*



CDP/CDX TRACK RANDOM*

Track random selects and plays tracks at random from the currently playing disc

RDM



Track Random

1. Press the RDM (Preset #3) button to begin track random mode
2. Track random will continue to select and play tracks at random until the mode is cancelled

04 00:01



13 00:01



06 00:01



Track Random Cancel

1. Press the RDM (Preset #3) button a second time to cancel track random mode

LCD Display

1. The LCD will display RDM until the function is cancelled

*NOTE: This function works identically in both CD Player and CD Changer modes.



CDP/CDX PAUSE*

Pause CD

1. Press the MUTE button to pause the CD and reduce the volume to minimum
2. Press the MUTE button a second time to resume playing the disc



PAUS

LCD Display

1. The LCD will display PAUS and the track # until the function is canceled

*NOTE: This function works identically in both CD Player and CD Changer modes.



DISC EJECT*



Disc Eject

1. Press the EJECT button to release the disc from the CD player
2. The source unit will revert to P.PLAY or EJ MUTE mode (see TUNER OPTIONS in this manual for further information on programming the default mode)
3. After ignition is turned off, it is possible to eject disc. However, this function may only be performed once with ignition off.

LCD Display

1. The LCD will display EJECT for 5 seconds
2. After 5 seconds, the LCD will revert to the previous display

Auto Reload

1. If the CD is left in the ejected position for more than 10 seconds the disc will automatically reload into the CD player
2. The auto reload operation will not restart playing the disc or affect any other current mode (Except EJ MUTE Mode)

*NOTE: This function works in CD Player mode only.

CD Changer Operation

(Optional Accessory)

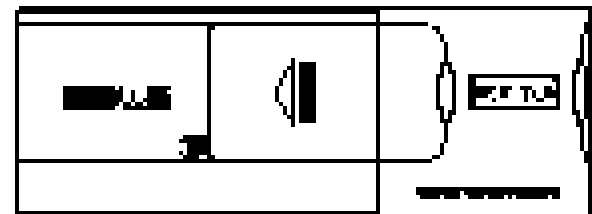

LOADING THE CD CHANGER



Loading Disc to the Magazine

1. Pull out the desired disc tray number from the magazine
2. Place the disc into the magazine label side up
3. Push the disc tray back into the magazine

NOTE: Discs numbers are arranged from the top down



Loading the Magazine to the CD Changer

1. The INSERT IN THIS DIRECTION arrow indicates the proper direction that the magazine should be loaded into the CD changer

CAUTION

Avoid installing or leaving the magazine where it would be subject to high temperatures such as from direct sunlight or from hot air from the heater. Doing so will damage the unit.



CD CHANGER MODE



CDX Play

CD Changer Mode

1. Press the MODE button until CDX PLAY is displayed
2. The CD changer will immediately begin playing track #1 of the first available disc
3. If the changer was previously initialized, the changer will resume playing the last track initialized

LCD Display

1. The LCD will continuously flash the number of the currently playing disc
2. When a disc begins playing, the track # & elapsed time will be displayed for 5 seconds
3. After 5 seconds the LCD will revert to the default display

NOTE: If no disc is loaded into the CD changer NO CD will be displayed and the source unit will revert back to TUNER mode.



CDX DISC SELECTION



Disc 1
Disc 2
Disc 3

Disc Selection

1. Press the TUNE UP button to select the next disc in the magazine
2. Press the TUNE DN button to select the previous disc in the magazine

LCD Display

1. The LCD will continuously flash the number of the currently playing disc
2. When a disc begins playing, the track # & elapsed time will be displayed for 5 seconds
3. After 5 seconds the LCD will revert to the default display

Considerations

CDX MODE: When the last track # on the current disc is reached, the next disc will be loaded in the CD changer and begin playing track #1

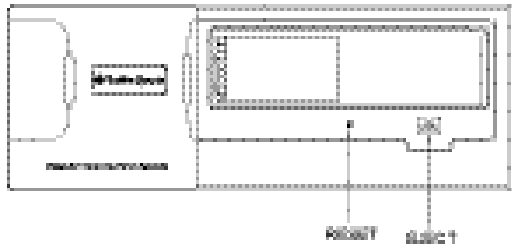

AUXILIARY OPERATION



CDX EJECT/RESET



Magazine Eject

1. Press the EJECT button to release the magazine disc from the CD changer
2. The source unit will revert to TUNER mode

NOTE: A disc may be ejected during any mode or if the radio power/ignition is off

LCD Display

1. The LCD will display NO CD

CD Changer Reset

Press the RESET button if the changer gets jammed during operation

•
RESET

AUX Mode*



TUNER →
CDP →
CDX →
AUX →

AUX Mode

1. Press the MODE button until AUX is displayed
2. The AUX input will immediately "see" the auxiliary audio input being fed into the AUX RCA jacks

LCD Display

1. AUX will be displayed for 5 seconds
2. After 5 seconds the LCD will revert to the default display

NOTE: The input signal connected to the AUX RCA jacks is fed into the source unit prior to the volume control. If the AUX input source has a constant (non-adjustable) output level, the volume control on the faceplate can properly adjust the amplitude. The maximum signal the AUX circuit can accept without clipping is 2.4V RMS. More than 2.4V RMS input voltage can be applied to the circuit, however the signal will be clipped (producing gain overlap).

*Feature available on RFX8230 only

IR REMOTE OPERATION

(RFX8210 Optional Accessory)

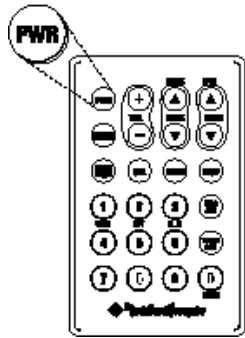

POWER ON/OFF

 <p>On ↓ Off ↓</p>	<ol style="list-style-type: none"> 1. Press the PWR button to turn on the radio 2. Press the PWR button a second time to turn off the radio <p>LCD Display</p> <p>When the radio is off (in sleep mode) the clock will be displayed</p>
---	--

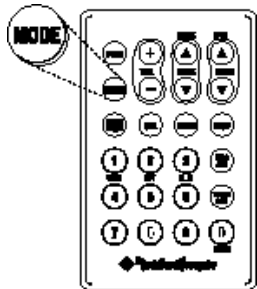

OPERATING MODE

 <p>TUNER ↓ CDP ↓ CDX ↓ AUX ↓</p>	<ol style="list-style-type: none"> 1. Consecutively press the MODE button to cycle through: TUNER>CDP>CDX>AUX* modes 2. Release the MODE button to select the appropriate operating mode <p><small>*This feature available on RFX8230 only</small></p>
--	---

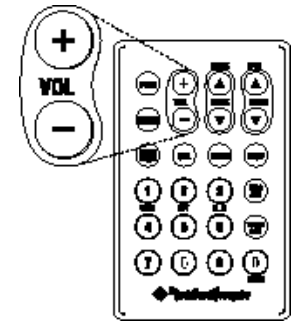

VOLUME UP/DOWN

 <p>VOL 25</p>	<p>Volume Up/Down</p> <ol style="list-style-type: none"> 1. Press the VOL(+) button to increase the volume 2. Press the VOL(-) button to decrease the volume <p>NOTE: The VOL button is also used to increase or decrease the Bass, Treble, Balance, Fader & Sum*. See Tone Controls in this section for further information.</p> <p><small>*This feature available on RFX8220 & RFX8230 only</small></p>
---	---

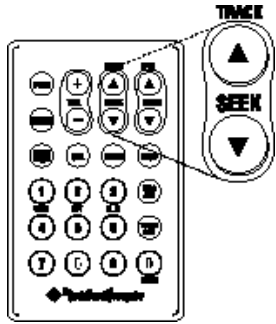

SEEK (TRACK)



↓

F1 101.5

Seek (TUNER Mode)

1. Press the SEEK UP button to automatically jump the tuner to the next strongest radio station
2. Press the SEEK DN button to automatically jump the tuner to the last strongest radio station
3. Press the SEEK UP/DN again to stop the tuner on the current radio station



↓

Track 07

Track Selection (CDP/CDX Mode)

1. Press the SEEK UP button to select the next track on the disc
2. Press the SEEK DN button to select the previous track on the disc

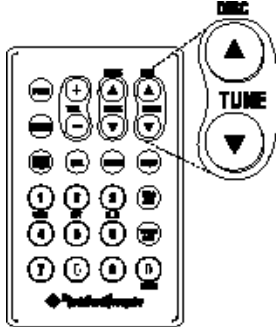

TUNE (DISC)



↓

F1 101.5

Tune (TUNER Mode)

1. Press the TUNE UP button to manually tune the radio station up the band
2. Press the TUNE DN button to manually tune the radio station down the band



↓

Disc 04

Disc Selection (CDX Mode)

1. Press the TUNE UP button to select the next disc in the magazine
2. Press the TUNE DN button to select the previous disc in the magazine

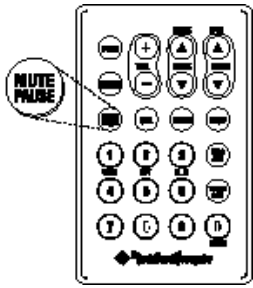

MUTE/PAUSE*



MUTE



T01 PAUS

Tuner Mute

1. Press the MUTE button to reduce the volume to minimum
2. Press the MUTE button a second time to revert the audio to the previous level

LCD Display

The LCD will display MUTE until the function is canceled

Pause CD (CDP/CDX Mode)

1. Press the MUTE/PAUSE button to pause the CD and reduce the volume to minimum
2. Press the MUTE/PAUSE button a second time to resume playing the disc

LCD Display

The LCD will display PAUS and the track # until the function is canceled

*NOTE: This function works identically in both CD Player and CD Changer modes.

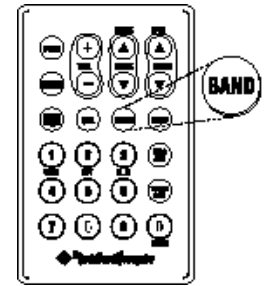

TONE CONTROLS



BAS

TRE

BAL

FAD

SUM**

VOL

1. Press the SEL button to cycle through BASS>TREBLE>BALANCE>FADER>SUM**>VOLUME
2. Press the VOL+ button to increase function
3. Press the VOL+ button to decrease function

Function	Display	Range	Default
Volume	VOL	0 to 50	12
Bass	BAS	-8 to +8	0
Treble	TRE	-8 to +8	0
Balance	BAL	L15 to R15	0
Fader	FAD	R15 to F15	0
Sum Out	SUM**	0 to 50	50

SOURCE TONE MEMORY

Individual Bass & Treble settings are memorized for TUNER / CDP / CDX / AUX* modes.

NOTE: If no adjustment is made after 5 seconds, the MENU knob will revert to VOLUME mode.

*Features available on RFX8230 only

**Features available on RFX8220 & RFX8230 only

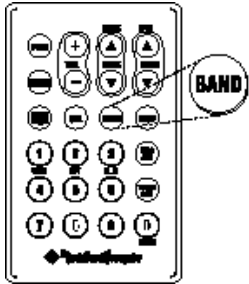

TUNER BAND

Selecting the Tuner Band

1. Press the BAND button to cycle through the tuner bank: FM1>FM2>FM3>AM1>AM2
2. Release the BAND button the select the desired tuner bank

-  FM1 
- FM2 
- FM3 
- AM1 
- AM2 

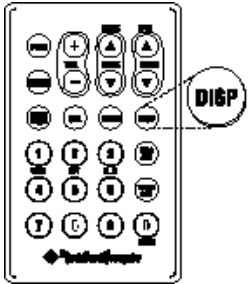

DISPLAY RECALL

Display Recall temporarily displays the clock, radio station, station title**, CD track/time, disc title* or aux* on the LCD for 5 seconds.

Display Recall (TUNER)

1. While in TUNER mode, press the DISP button to cycle through CLOCK>RADIO STATION>STATION TITLE**
2. After 5 seconds, the display will revert to the default display



Display Recall (CDP/CDX)

1. While in CDP/CDX mode, press the DISP button to cycle through CLOCK>TRACK/TIME>DISC TITLE*
2. After 5 seconds, the display will revert to the default display

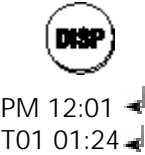

Display Recall (AUX)*

1. While in AUX mode, press the DISP button to switch between CLOCK>AUX*
2. After 5 seconds, the display will revert to the default display



NOTE: See DEFAULT/RECALL DISPLAY in the Basic Operation section of this manual for more information on programming the

*Features available on RFX8230 only
 **Features available on RFX8220 & RFX8230 only

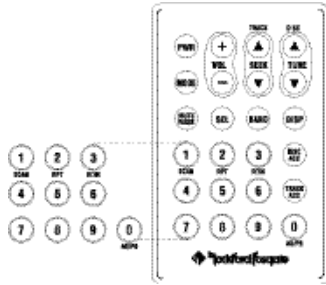

DIRECT PRESET ACCESS

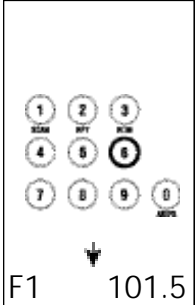

Direct Preset Access

1. Press the number (1-2-3-4-5-6) to access the desired tuner preset
2. The CD player or CD changer will immediately load the selected track and begin playing

LCD Display

1. The LCD will display the tuner bank and the tuner frequency being accessed for 5 seconds
2. After 5 seconds the LCD will revert to the default display

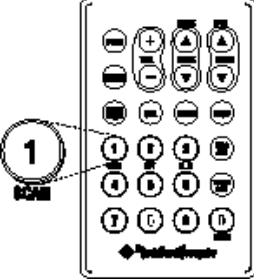

TRACK SCAN*



Track scan plays the intro to each track for 10 seconds before moving to the next track on the currently playing disc

Track Scan

1. Press the SCAN (Preset #1) button to begin track scan mode
2. Track scan will continue to scan until the mode is cancelled

Track Scan Cancel

1. Press the SCAN (Preset #1) button a second time to cancel track scan mode

LCD Display

1. The LCD will display SCAN until the function is cancelled
2. The LCD will display the track # and elapsed time for 5 seconds each time a new track begins its intro scan
3. After 5 seconds the LCD will revert to the default display

**NOTE: This function works identically in both CD Player and CD Changer modes.*

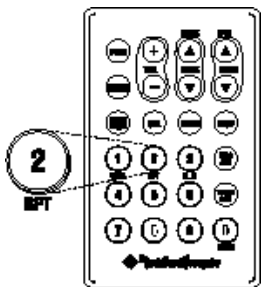

TRACK REPEAT*

Track Repeat plays the currently playing track over again from the beginning

Track Repeat

1. Press the RPT (Preset #2) button to begin track repeat mode
2. Track repeat will continue to repeat the current track until the mode is cancelled

Track Repeat Cancel

1. Press the RPT (Preset #2) button a second time to cancel track repeat mode

LCD Display

The LCD will display RPT until the function is cancelled

**NOTE: This function works identically in both CD Player and CD Changer modes.*

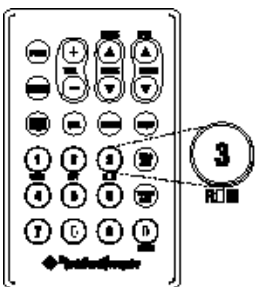
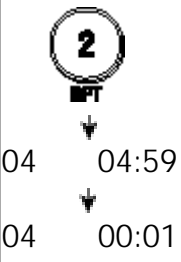

TRACK RANDOM*

Track random selects and plays tracks at random from the currently playing disc

Track Random

1. Press the RDM (Preset #3) button to begin track random mode
2. Track random will continue to select and play tracks at random until the mode is cancelled

Track Random Cancel

1. Press the RDM (Preset #3) button a second time to cancel track random mode

LCD Display

The LCD will display RDM until the function is cancelled

**NOTE: This function works identically in both CD Player and CD Changer modes.*

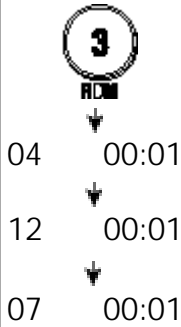

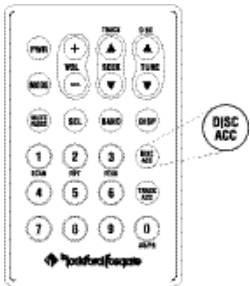

DIRECT DISC ACCESS

Direct Disc Access allows any disc in the magazine to be immediately selected and played. This method is faster than manually cycling through each disc in the magazine.

Direct Disc Access

1. While in CDX mode, press the DISC ACC button to select Direct Disc Access mode
2. Press the number (1-2-3-4-5-6-7-8-9-0) to access the desired disc in the magazine
3. The CD changer will immediately load the selected disc and begin playing track #1

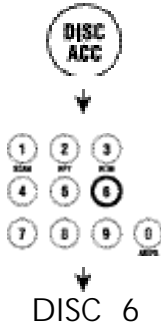

LCD Display

1. The LCD will display DISC and the disc # being accessed for 5 seconds
2. After 5 seconds the LCD will revert to the default display

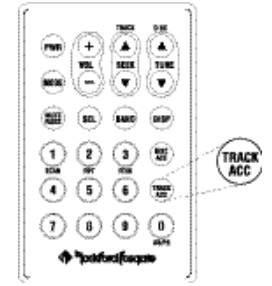

DIRECT TRACK ACCESS*

Direct Track Access allows any track to be immediately selected and played. This method is faster than manually cycling through each track on the disc.

Direct Track Access

1. While in CDP/CDX mode, press the TRACK ACC button to select Direct Track Access mode
2. Press the number (1-2-3-4-5-6-7-8-9-0) to access the desired track on the disc
3. The CD player or CD changer will immediately load the selected track and begin playing

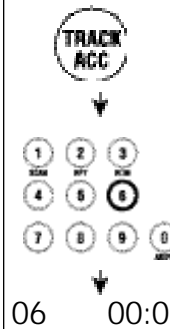

LCD Display

1. The LCD will display TRACK and the track # being accessed for 5 seconds
2. After 5 seconds the LCD will revert to the default display

**NOTE: This function works identically in both CD Player and CD Changer modes.*

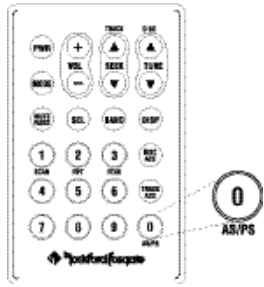

AUTO STORE/ PRESET SCAN

(press & hold)



AS/PS

- FM1 →
- FM2 →
- FM3 →
- AM1 →
- AM2 →



AS/PS

AUTO STORE

1. Press and hold the AS/PS button to automatically select the strongest radio stations and store them in the tuner banks.
2. Auto Store will store radio stations individually in the desired tuner bank (FM1/FM2/FM3/AM1/AM2).

PRESET SCAN

1. Press the AS/PS button to cycle through each radio station stored in memory. Each preset radio station will play for 5 seconds before moving to the next preset.
2. Press the AS/PS button again to stop Preset Scan on the currently playing radio station.

SOURCE UNIT TROUBLESHOOTING

SYMPTOM	DIAGNOSIS	REMEDY
Source Unit does not turn on	Voltage applied to Red and Yellow wires is not between 10.8 and 16 volts or there is no voltage present	Check battery, fuses and connections and repair or replace as necessary. If voltage is above +16 volts, have the electrical system inspected by an authorized car service center.
	Source unit is not properly grounded	Check wiring and repair as necessary
No backlight illumination	Detachable faceplate not properly connected	Detach faceplate and reinstall into chassis
Speakers pop when turning Source Unit On/Off	Auto antenna and remote B+ are not configured properly	Check wiring and repair as necessary. Refer to "Wiring the System" section of this manual for further information
	Bad component in the signal chain	Check connections and bypass additional components (crossovers and equalizers) between the source unit and the amplifier. Connect one component at a time to determine the culprit. Connect this component to the Blue wire and check for pops. If pops persist, repair or replace component as necessary
Tuner cannot "tune-in" any radio stations	Antenna is disconnected	Check connections and repair as necessary
Tuner has poor reception	Antenna is disconnected or not properly grounded to vehicle	Check connections and installation of antenna and repair or replace as necessary
	Antenna cable is intermittent or damaged	Disconnect antenna and test with known working antenna. If tuner works, check installation and repair antenna wiring as necessary
	Antenna is wrong type for AM/FM frequencies	Consult your local Authorized Rockford Fosgate Dealer for proper antenna selection

SYMPTOM	DIAGNOSIS	REMEDY
Disc will not load into Source Unit (also see error codes)	Voltage applied to Red and Yellow wires is not between 10.8 and 16 volts or there is no voltage present	Check battery, fuses and connections and repair or replace as necessary. If voltage is above +16 volts, have the electrical system inspected by an authorized car service center
Disc will not eject (also see error codes)	Voltage applied to Yellow wire is not between 10.8 and 16 volts or there is no voltage present	Check battery, fuses and connections and repair or replace as necessary. If voltage is above +16 volts, have the electrical system inspected by an authorized car service center
ERROR 1 (Initialize Error)	No initialization	Press the reset button
	Mechanism is jammed and loading motor (or driving circuit) is defective	Repair the mechanism and loading motor (or driving circuit)
ERROR 3 (Loading Error)	Foreign objects are preventing the disc from loading	Check CDP mechanism load area by removing faceplate and repair as necessary
	Loading area in mechanism and loading motor (or driving circuit) is defective	Repair the mechanism and loading motor (or driving circuit)
ERROR 4 (Eject Error)	Foreign objects are preventing the disc from ejecting	Check CDP mechanism eject area by removing faceplate and repair as necessary
	Ejecting area in mechanism and ejecting motor (or driving circuit) is defective	Repair the mechanism and loading motor (or driving circuit)
ERROR 6 (Transverse Error)	Transverse motor or switch is defective. Traverse area damaged	Check CD mechanism motor, switch and transverse area.

SYMPTOM	DIAGNOSIS	REMEDY
ERROR 7 (Servo Error)	Excessive dirt or dust on disc	Clean disc to remove dirt or dust as necessary
	Disc is warped cracked or severely damaged	Put in a different disc!
	Excessive scratches on disk	Put in a different disc!
ERROR 9 (TOC Error)	Disc is warped cracked or severely damaged	Put in a different disc!
	The laser pickup is defective	Have a service center repair the laser pickup
	Servo unit in CDP mechanism is not operating properly	Check the servo circuit area and repair as necessary
Radiated Noises	No RF suppression of blower motors	Connect filter cap (Radio Shack #272-1085) in-line on B+ as close to blower motor as possible
	No RF suppression of switches	Connect a .1 μ f - .01 μ f non-polarized capacitor across switch contacts
CD skips excessively	Source unit mounted at an incorrect angle	Check mounting angle of source unit (mount within $\pm 20^\circ$ from horizontal) and repair as necessary
	Source unit not secured properly (Standard Mount)	Check tightness of installation sleeve and backstrap and repair or replace as necessary
	Source unit not secured properly (ISO Mount)	Check tightness of mounting screws and repair or replace as necessary

SYMPTOM	DIAGNOSIS	REMEDY
Engine Noise	Source unit is not grounded properly	Check connections and repair wiring as necessary
	Noise is radiating into RCA signal cable	Check connections, run the RCA cables on a different route away from sources of high current
	Bad component in the signal chain	Check connections, bypass additional components (crossovers and equalizers) between the Source unit and the amplifier. Connect one component at a time to determine the culprit. Repair or replace components as necessary
	Noise is radiating into the speaker cables	Disconnect existing speakers and connect a test speaker to the output terminals or the source unit. If noise is gone, reroute the speaker cables away from sources of high current
	Multiple grounds in the audio system	Check ground connections and connect amplifiers, signal processors, and other components to a central location or try a different grounding point on the chassis

CD CHANGER TROUBLESHOOTING

SYMPTOM	DIAGNOSIS	REMEDY
Error 1 (Initialize Error)	Disc unit can't detect magazine	Press the eject button and pull out the magazine. Press the reset button
	Magazine tray load/unload problem	Check tray load/unload area
	Magazine sensor is defective	Have a service center check the magazine sensing switch
Error 2 (Magazine Eject Error)	Can't eject magazine	Press the reset button
	Magazine emitting spring is damaged	Have a service center inspect and repair as necessary
	Magazine tray is jammed	Inspect and repair as necessary
Error 3 (Loading Error)	Tray loading has not completed after 5 seconds	Press the eject button, pull out the magazine and try again. Press the reset button
	Loading mechanism and loading motor (or driving circuit) is defective	Repair mechanism and loading motor (or driving circuit)
Error 4 (Unloading Error)	Tray unloading has not completed after 5 seconds	Press the eject button, pullout the magazine and try again. Press the reset button
	Unloading mechanism and unloading motor (or driving circuit) is defective	Have a service center repair mechanism and loading motor (or driving circuit)
Error 5 (Elevator Error)	Magazine tray is jammed	Repair the CD changer mechanism. Press the reset button.

SYMPTOM	DIAGNOSIS	REMEDY
Error 7 (Focus Error)	The laser pick-up is defective	Repair the laser pick-up
	Disc is warped, cracked or damaged	Put in a new disc
Error 9 (TOC Error)	Disc is warped, cracked or severely damaged.	Eject damaged disc from source unit and play only non-damaged discs
	The laser pick-up is defective	Have a service center repair the laser pick-up
NO CD (No Disc Error)	Magazine is empty or not installed in the unit	Check the magazine and insert discs
NO CONN (Communication Error)	8-pin DIN cable is disconnected from the CDX mechanism or source unit	Check the connection of 8-pin DIN cable between the CDX and unit

SYMPTOM	DIAGNOSIS	REMEDY
CD Changer does not operate	CDX cable is intermittent or severely damaged	Check connections and repair or replace CDX cable as necessary
	CDX cable is disconnected from the Source Unit or CD Changer	Check connections at the Source unit and CD Changer and repair wiring as necessary
	Communication problem	Press "Reset" button on CD Changer
Disc is jammed in the CD Changer	Disc load/unload problem	Press "Reset" button on CD Changer. If CD Changer still does not operate, see your Local Authorized Rockford Fosgate Dealer

IR REMOTE TROUBLESHOOTING

SYMPTOM	DIAGNOSIS	REMEDY
IR Remote has poor range	Batteries are weak	Check battery condition and replace as necessary with (1) CR2025 (+3 volt) battery
	Excessive dirt or dust on IR Remote transmitter lens	Clean transmitter lens with Plexiglas solution and a non-abrasive cloth as necessary
	Excessive dirt or dust on source unit receiver lens	Clean receiver lens (compact disc logo) with Plexiglas solution and a non-abrasive cloth as necessary
	IR remote is outside of optimum transmitting range	Operate IR remote within approximately 15 ft and $\pm 45^\circ$ from horizontal of the Source unit's faceplate
	High sunlight conditions	Operate IR remote closer to Source Unit
IR Remote does not work (LED does not illuminate)	Batteries are dead	Check battery condition and replace as necessary with (1) CR2025 (+3 volt) battery
	Battery is installed incorrectly	Check battery installation and repair as necessary (polarity is indicated on pc board)

LIMITED WARRANTY INFORMATION

Rockford Corporation offers a limited warranty on Rockford Fosgate products on the following terms:

Length of Warranty

1 year on source units

What is Covered

This warranty applies only to Rockford Fosgate products sold to consumers by Authorized Rockford Fosgate Dealers in the United States of America or its possessions. Product purchased by consumers from an Authorized Rockford Fosgate Dealer in another country are covered only by that country's Distributor and not by Rockford Corporation.

Who is Covered

This warranty covers only the original purchaser of Rockford product purchased from an Authorized Rockford Fosgate Dealer in the United States. In order to receive service, the purchaser must provide Rockford with a copy of the receipt stating the customer name, dealer name, product purchased and date of purchase.

Products found to be defective during the warranty period will be repaired or replaced (with a product deemed to be equivalent) at Rockford's discretion.

What is Not Covered

1. Damage caused by accident, abuse, improper operations, water, theft
2. Any cost or expense related to the removal or reinstallation of product
3. Service performed by anyone other than Rockford or an Authorized Rockford Fosgate Service Center
4. Any product which has had the serial number defaced, altered, or removed
5. Subsequent damage to other components
6. Any product purchased outside the U.S.
7. Any product not purchased from an Authorized Rockford Fosgate Dealer

Limit on Implied Warranties

Any implied warranties including warranties of fitness for use and merchantability are limited in duration to the period of the express warranty set forth above. Some states do not allow limitations on the length of an implied warranty, so this limitation may not apply. No person is authorized to assume for Rockford Fosgate any other liability in connection with the sale of the product.

How to Obtain Service

Please call 1-800-669-9899 for Rockford Customer Service. You must obtain an RA# (Return Authorization number) to return any product to Rockford Fosgate. You are responsible for shipment of product to Rockford.

Ship to: **Electronics**
Rockford Corporation
Warranty Repair Department
2055 E. 5th Street
Tempe, AZ 85281
RA#: _____

Ship to: **Speakers**
Rockford Acoustic Design
(Receiving-speakers)
609 Myrtle N.W.
Grand Rapids, MI 49504
RA#: _____

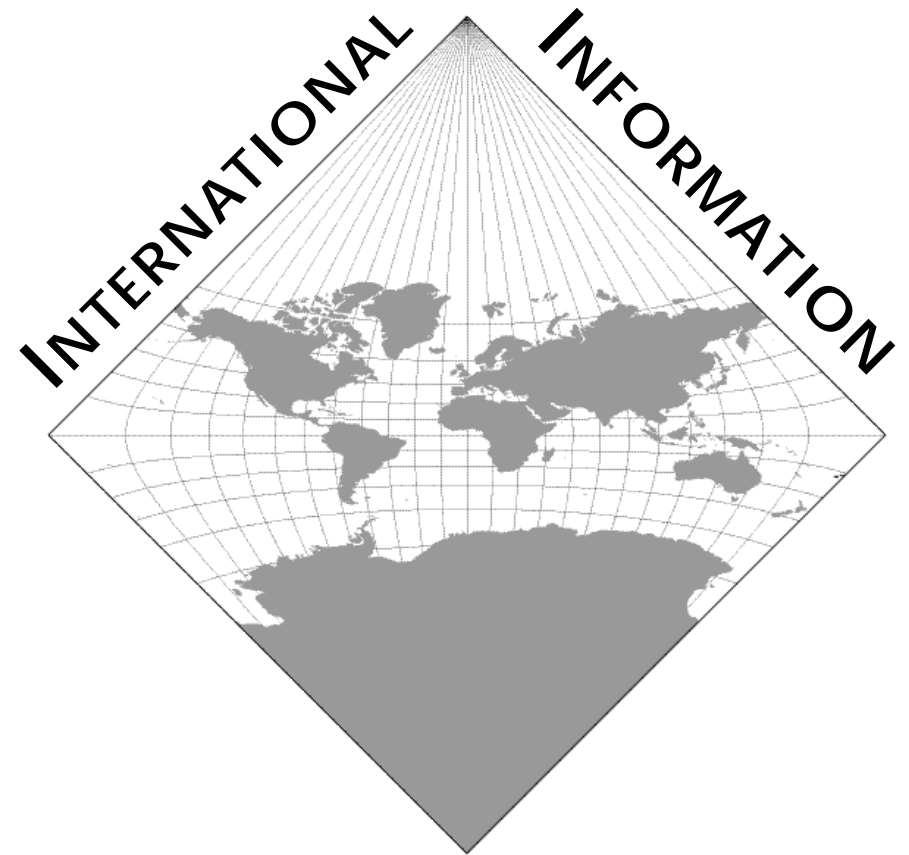



PRINTED IN KOREA

Rockford Fosgate
Rockford Corporation
546 South Rockford Drive
Tempe, Arizona 85281 U.S.A.
In U.S.A., (480) 967-3565
In Europe, Fax (49) 8503-934014
In Japan, Fax (81) 559-79-1265

www.rockfordfosgate.com

E.W.R.
4/99